

Article number: 53090105

Description: KLEE Hydraulic lubricating nipple DIN 71412  
H1 straight, M8x1,0

## Measures

---

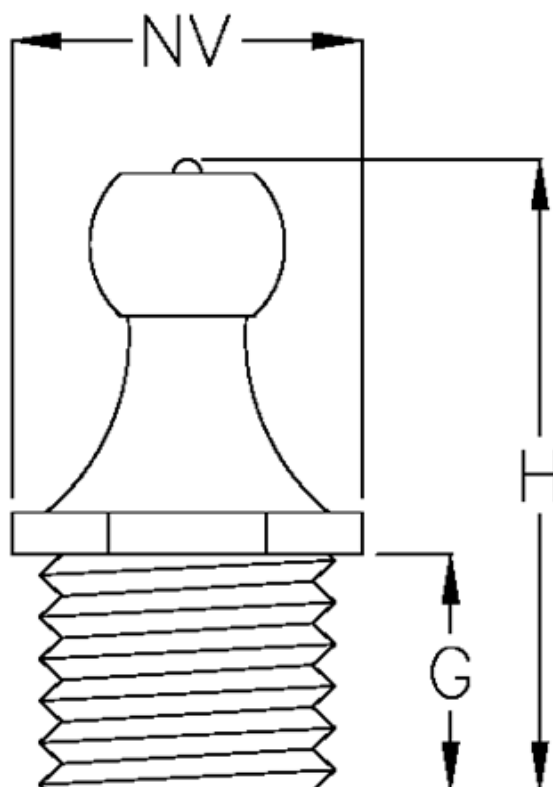

G = 6

H = 16

NV = 8,9

Thread = M8x1,0